



# Outdoor LoRaWAN<sup>®</sup> Hotspot

## UG67

User Guide



## Safety Precautions

Milesight will not shoulder responsibility for any loss or damage resulting from not following the instructions of this operating guide.

- The device must not be modeled in any way.
- Do not place the device close to objects with naked flames.
- Do not place the device where the temperature is below/above the operating range.
- Do not power on the device or connect it to other electrical devices when installing.
- Ensure all connectors are tightened for water protection when used outdoors.
- Check lightning protection when used outdoors.
- Do not connect or power the equipment using cables that have been damaged.

## Related Documents

Document	Description
UG67 Datasheet	Datasheet for UG67 LoRaWAN® Hotspot.

The related documents are available on the Milesight website: <https://www.milesight-iot.com>

## Declaration of Conformity

UG67 conforms with the essential requirements and other relevant provisions of the CE, FCC, and RoHS.

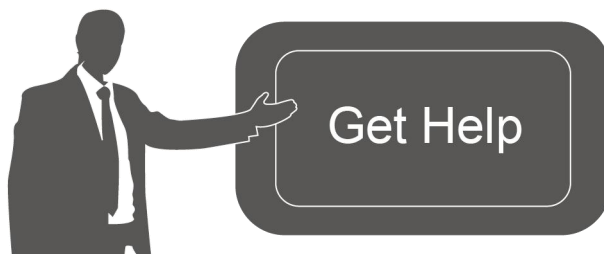

For assistance, please contact  
Milesight technical support:  
Email: [iot.support@milesight.com](mailto:iot.support@milesight.com)  
Tel: 86-592-5085280  
Fax: 86-592-5023065

## Revision History

Date	Doc Version	Description
March 29, 2022	V1.0	Initial version
July 29, 2022	V1.1	<ol style="list-style-type: none"> <li>1. Delete Helium Sync page, add Hotspot page</li> <li>2. Update Helium App contents</li> <li>3. Add 1.3m antenna accessory and installation guide</li> </ol>

# Contents

1. Packing List .....	4
2. Hardware Introduction .....	5
2.1 Overview .....	5
2.2 Dimensions (mm) .....	5
2.3 LED Indicators .....	5
2.4 Reset Button .....	6
2.5 DC Power Connector .....	6
3. Hardware Installation .....	7
3.1 SIM Card Installation .....	7
3.2 Antenna Installation .....	7
3.3 Ethernet Cable & Power Cable Installation .....	8
3.4 Power Supply .....	8
3.5 Hotspot Installation .....	9
3.5.1 Wall Mounting .....	9
3.5.2 Pole Mounting .....	10
4. Login the Web GUI .....	11
4.1 Wireless Access .....	11
4.2 Wired Access .....	13
5. Network Connection .....	15
5.1 Configure the Ethernet Connection .....	15
5.2 Configure the Wi-Fi Connection .....	15
5.3 Configure the Cellular Connection .....	17
6. Helium Hotspot Setup .....	18
7. Helium Advanced Setting .....	22
7.1 Hotspot .....	22
7.2 Onboarding .....	23
7.3 Operation .....	23
8. Packet Forwarder Configuration .....	25
9. Network Server Configuration .....	26
9.1 Connect UG67 to Milesight IoT Cloud .....	26
9.2 Connect UG67 to MQTT/HTTP Server .....	28

## 1. Packing List

Before you begin to install the UG67 LoRaWAN® hotspot, please check the package contents to verify that you have received the items below.

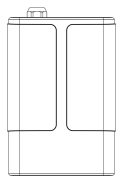

1 × UG67 Hotspot

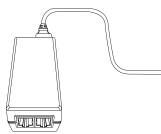

1 × PoE Injector

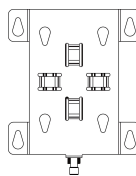

1 × Mounting Bracket



4 × Wall Mounting Kits



1 × Cable Gland



1 × Card Dust Cover



2 × Hose Clamps



1 × DC Power Cable



1 × LoRa Antenna  
(60 cm)



1 × Quick Start Guide



1 × Warranty Card

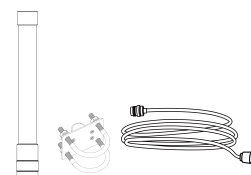

1.3m LoRa Antenna Kit  
(Optional)



**If any of the above items is missing or damaged, please contact your sales representative.**

## 2. Hardware Introduction

### 2.1 Overview

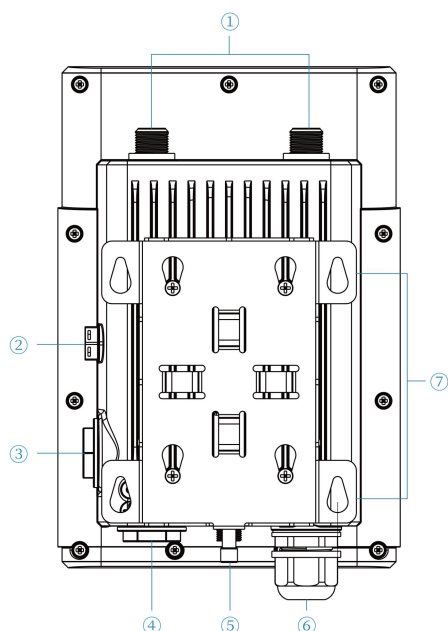

- ① LoRa Antenna Connector
- ② Vent Plug
- ③ SIM Slot & Micro SD Slot
- ④ LED Area & Type-C Port & Reset Button
- SYS: System Indicator
- LoRa: LoRa Indicator
- LTE: Cellular Indicator
- ⑤ DC Power Connector (Solar Connector)
- ⑥ Ethernet Port (PoE)
- ⑦ Mounting Bracket

### 2.2 Dimensions (mm)

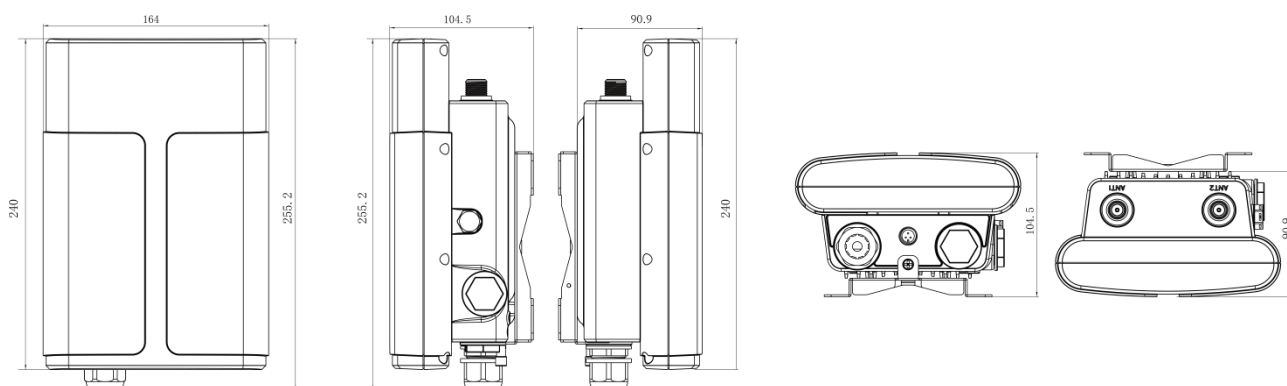

### 2.3 LED Indicators

LED	Indication	Status	Description
SYS	System Status	Green Light	Static: the system is running properly
		Red Light	The system goes wrong
LoRa	LoRa Status	Off	Packet Forwarder mode is running off
		Green Light	Packet Forwarder mode is running well
LTE	Cellular Status	Off	SIM card is registering or fails to register (or there are no SIM cards inserted)
		Green Light	Blinking slowly: SIM card has been registered and is ready for dial-up

			Blinking rapidly: SIM card has been registered and is dialing up now
			Static: SIM card has been registered and dialed up successfully

## 2.4 Reset Button

Function	Description	
	SYS LED	Action
Reset	Static Green	Press and hold the reset button for more than 5 seconds.
	Static Green → Rapidly Blinking	Release the button and wait.
	Off → Static Green	The hotspot resets to factory default.

## 2.5 DC Power Connector

UG67 supports 12 VDC or solar supply via M12 connector.

Pin	Color	Description
1	Black	GND
2	White	Reserved
3	Yellow	Reserved
4	Red	+12V

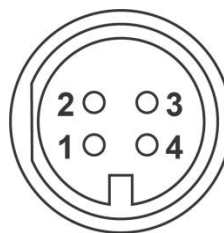

## 3. Hardware Installation

### 3.1 SIM Card Installation

- A. Insert the SIM card into the device according to the direction icon on the device. If you need to take out the card, press the card and it will pop up automatically.
- B. Tighten the dust cover with a wrench to prevent water damage.

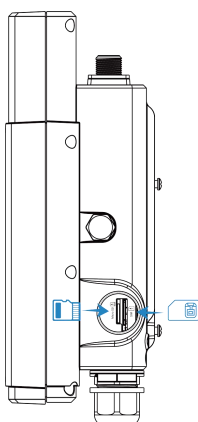

### 3.2 Antenna Installation

UG67 supports multiple LoRa antenna types. It's suggested to select single antenna mode for better Helium network coverage. The external antenna must be installed on the ANT1 connector. When installing in outdoors, please use electrical insulation tapes and waterproof insulation tapes to cover the connectors.

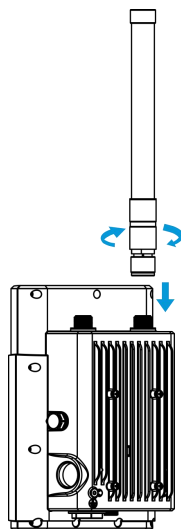

If you use 1.3m high gain antenna kit, fix the LoRa antenna to a pole via antenna clamp kit: pass the LoRa antenna through the antenna clamp and fix it with 4 screws, then wrap the U-bolt around a pole and fix the clamp with nuts and other accessories. After installation, connect the antenna to gateway ANT1 antenna connector via the coaxial cable. **Note that do not install this antenna to hotspot directly.**

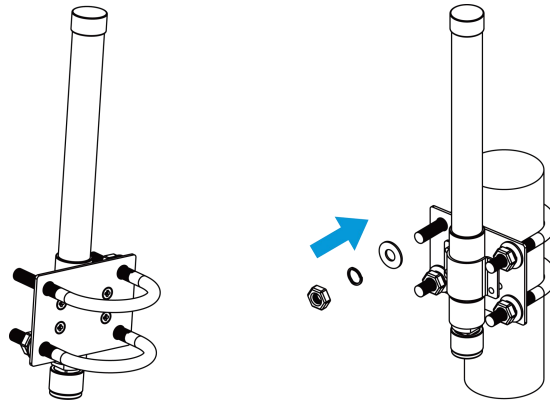

### 3.3 Ethernet Cable & Power Cable Installation

Pass the Ethernet cable through the cable gland and rotate the cable gland to the hotspot, then tighten the cable gland with a wrench.

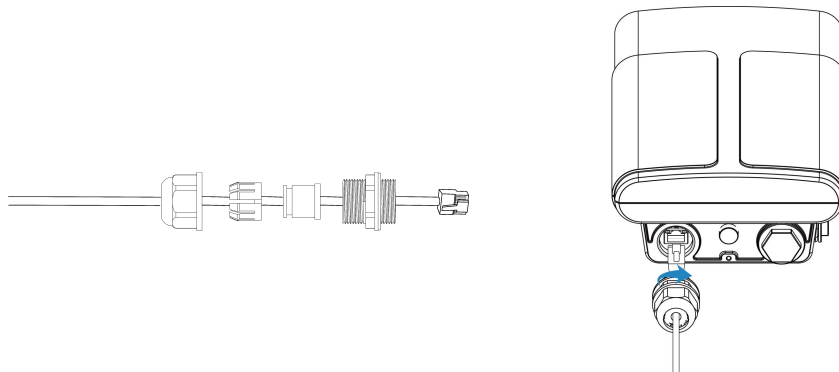

For DC or solar power supply, remove the protective cap of the power connector and rotate the DC power cable into the power connector.

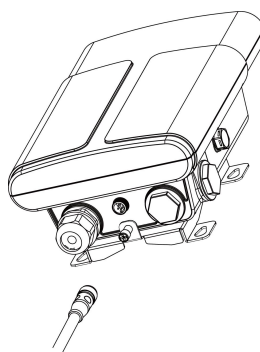

### 3.4 Power Supply

UG67 can be powered by 802.3af standard PoE or 12VDC. If there is not PoE switch, please use a PoE injector to power on the UG67 as below:



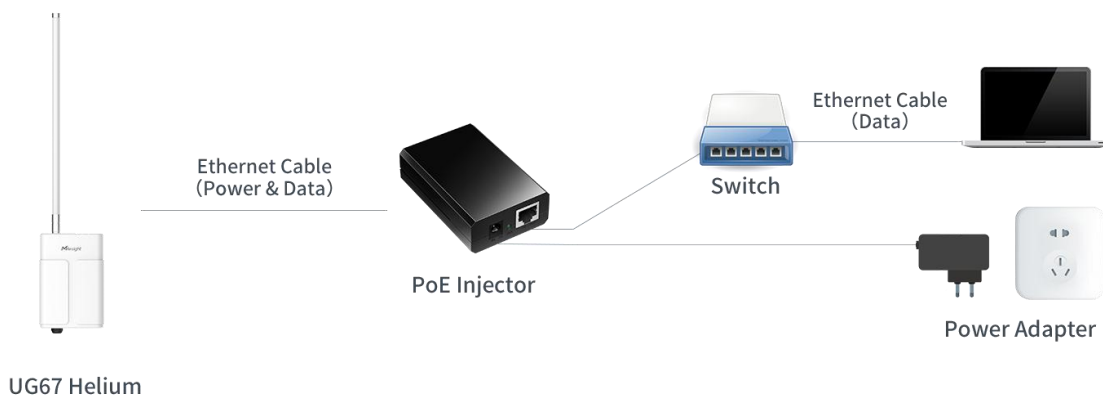

## 3.5 Hotspot Installation

UG67 can be mounted to a wall or a pole. Before you start, make sure that your SIM card has been inserted, your antennas have been attached and all cables have been installed.

**Note:** Do not connect the device to the power supply or other devices when installing.

### 3.5.1 Wall Mounting

**Preparation:** mounting bracket (with a screw), wall plugs, wall mounting screws and other required tools.

A. Align the mounting bracket horizontally to the desired position on the wall, use a marker pen to mark four mounting holes on the wall, and then remove the mounting bracket from the wall.

**Note:** The connecting lines of adjacent points are at right angles.

B. Drill four holes with a depth of 32 mm by using your drill with a 6 mm drill bit on the positions you marked previously on the wall.

C. Insert four wall plugs into the holes respectively.

D. Mount the mounting bracket horizontally to the wall by fixing the wall mounting screws into the wall plugs.

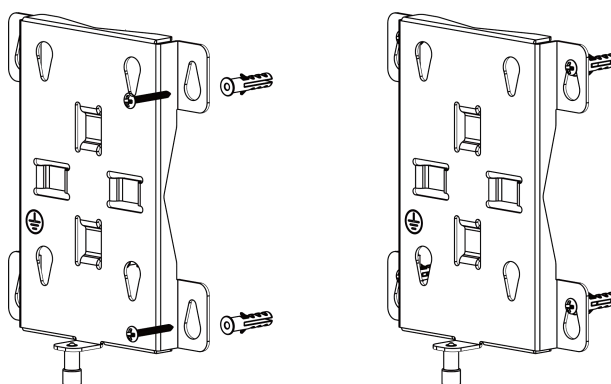

E. Hang the device to the mounting bracket via bracket mounting screws on the back of the device, then screw the bracket screw to the bottom of the device.

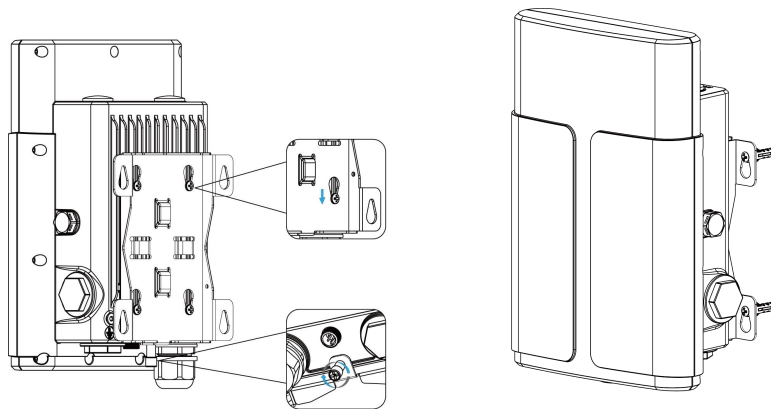

### 3.5.2 Pole Mounting

**Preparation:** mounting bracket (with a screw), hose clamp and other required tools.

- Loosen the hose clamp by turning the locking mechanism counter-clockwise.
- Straighten out the hose clamp and slide it through the rectangular rings in the mounting bracket, wrap the hose clamp around the pole.
- Use a screwdriver to tighten the locking mechanism by turning it clockwise.

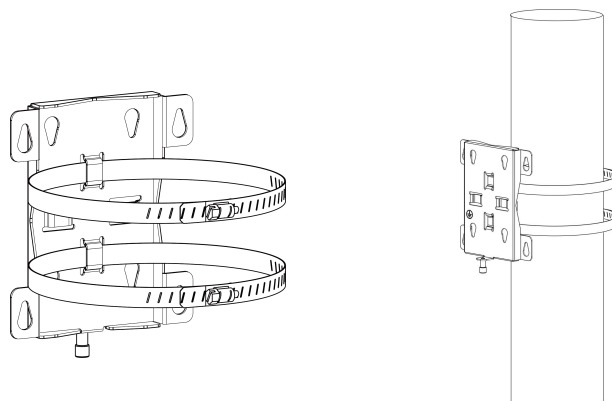

- Hang the device to the mounting bracket via bracket mounting screws on the back of the device, then screw the bracket screw to the bottom of the device.

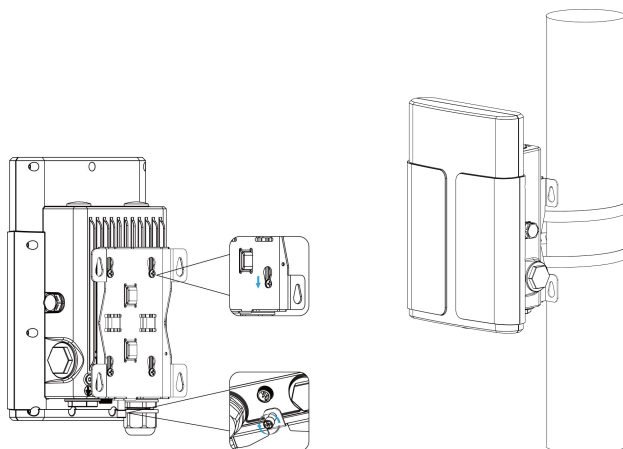

## 4. Login the Web GUI

UG67 provides a web-based configuration interface for management. If this is the first time you configure the hotspot, please use the default settings below:

ETH IP Address: **192.168.23.150**

Wi-Fi IP Address: **192.168.1.1**

Wi-Fi SSID: **Gateway\_\*\*\*\*\***

Username: **admin**

Password: **password**

### 4.1 Wireless Access

A. Enable wireless network connection on your computer and search for access point “**Gateway\_\*\*\*\*\***” to connect it.

B. Open a web browser on your PC (Chrome is recommended) and type in the IP address **192.168.1.1** to access the web GUI, enter the username and password, click “Login”.

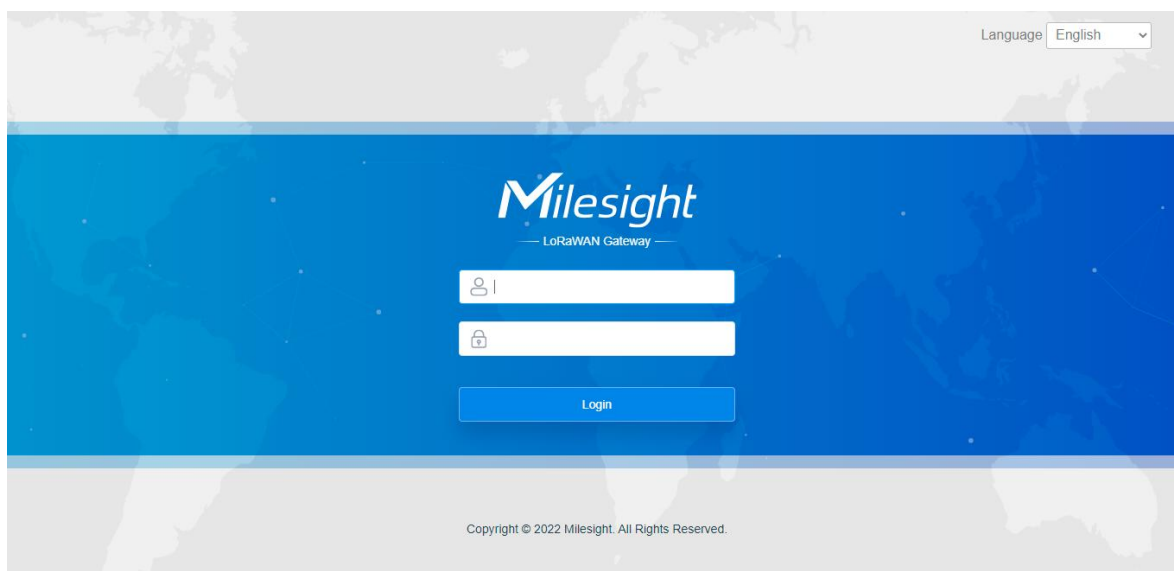

**⚠ If you enter the username or password incorrectly more than 5 times, the login page will be locked for 10 minutes.**

C. After logging, follow the guide to complete the basic configurations. It's suggested to change the password and keep the antenna type by default.

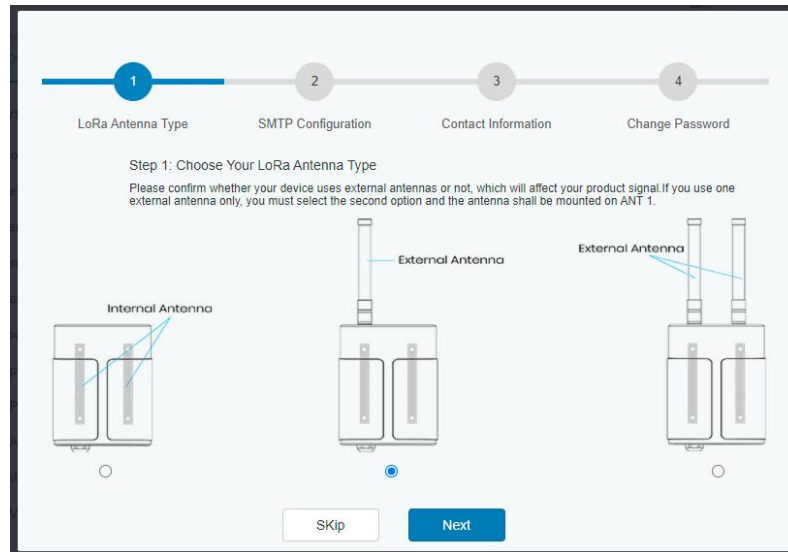

After the guide completed, you can view system information and perform more advanced settings.

System Information	Value
Model	UG67-868M-H32
Region	EU868
Serial Number	6843C1074025
Firmware Version	61.1.0.2-a2
Hardware Version	V2.0
Local Time	2022-03-29 16:24:51 Tuesday
Uptime	02:32:54
CPU Load	2%
RAM (Available/Capacity)	505MB/2.0GB (24.66%)
eMMC (Available/Capacity)	28.3GB/29.0GB (97.50%)
Micro SD (Available/Capacity)	14.8GB/14.8GB (100.00%)
NVMe SSD (Available/Capacity)	220.6GB/233.7GB (94.37%)



**Please disable WLAN feature or add password after you completed all hotspot settings!**

## 4.2 Wired Access

Connect PC to UG67 ETH port through PoE injector. The following steps are based on Windows 10 operating system for your reference.

A. Go to “Control Panel” → “Network and Internet” → “Network and Sharing Center”, then click “Ethernet” (May have different names).

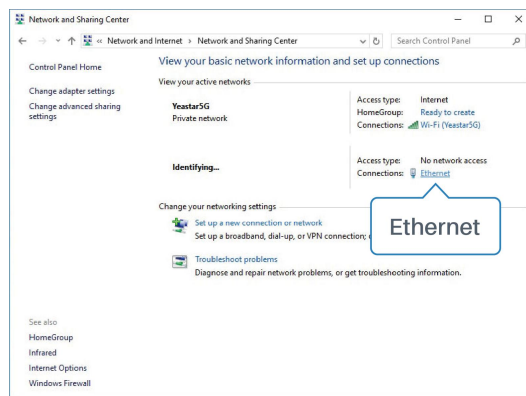

B. Go to “Properties” → “Internet Protocol Version 4(TCP/IPv4) ”and select “Use the following IP address”, then assign a static IP manually within the same subnet of the hotspot.

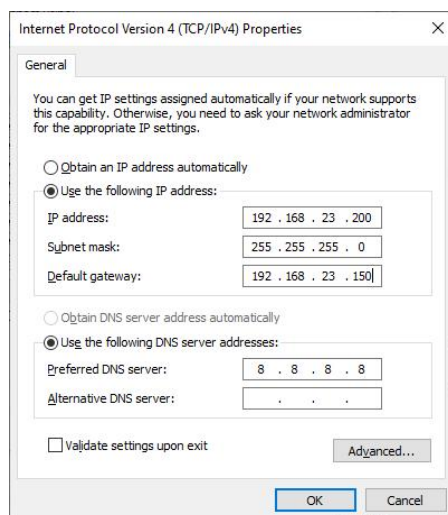

C. Open a web browser on your PC (Chrome is recommended) and type in the IP address **192.168.23.150** to access the web GUI, enter the username and password, click “Login”.



**If you enter the username or password incorrectly more than 5 times, the login page will be locked for 10 minutes.**

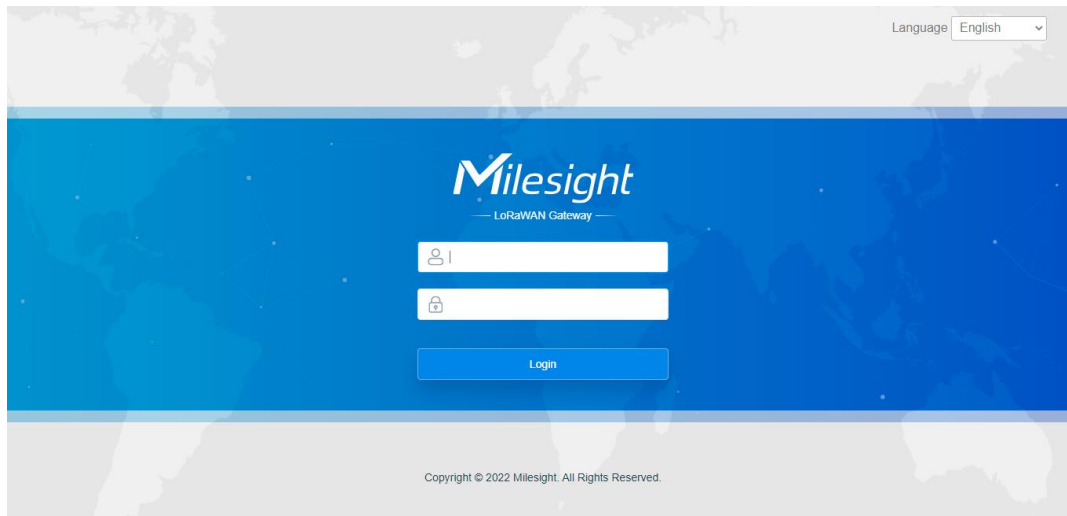

D. After logging, follow the guide to complete the basic configurations. It's suggested to change the password and keep the antenna type by default.

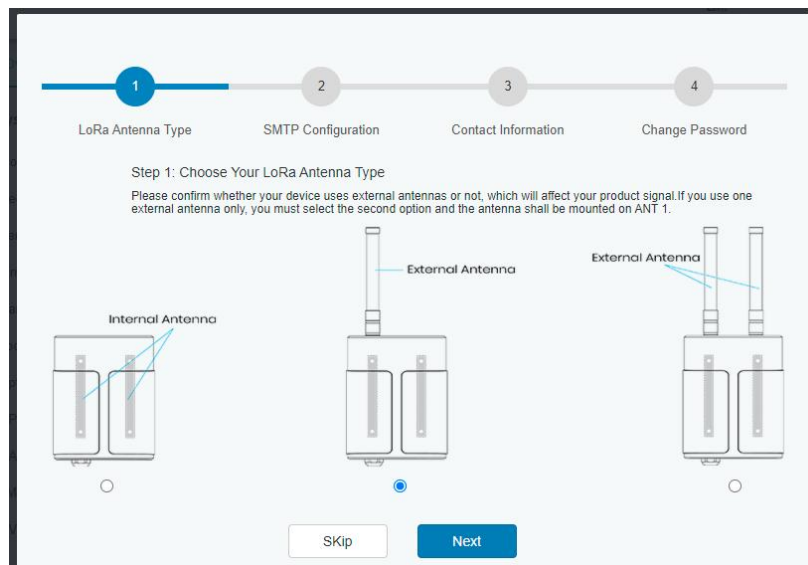

After the guide completed, you can view system information and perform more advanced settings.

For your device security, please change the default password

Status	Overview	Network	WLAN	VPN	Host List	Help
Packet Forwarder	<b>System Information</b>					<b>Model</b> Show the model name of router.
Network Server	Model		UG67-868M-H8			<b>Region</b> Show the Region of router.
Helium	Region		EU868			<b>Serial Number</b> Show the serial number of router.
Network	Serial Number		6819B4355156			<b>Firmware Version</b> Show the current firmware version of router.
System	Firmware Version		61.1.0.5			<b>Hardware Version</b> Show the current hardware version of router.
Maintenance	Hardware Version		V1.3			<b>Local Time</b> Show the current local time of system.
APP	Local Time		2022-04-27 13:51:18 Wednesday			<b>Uptime</b> Show the information on how long the router has been running.
	Uptime		1days,23:48:22			
	CPU Load		3%			
	RAM (Available/Capacity)		93MB/512MB (18.16%)			
	eMMC (Available/Capacity)		2.4GB/3.0GB (80.00%)			

Manual Refresh Refresh

## 5. Network Connection

This section explains how to connect the hotspot to the network via WAN connection, Wi-Fi or cellular.

### 5.1 Configure the Ethernet Connection

A. Go to “Network” → “Interface” → “Port” page to select the connection type and configure Ethernet port information, click “Save & Apply” for changes to take effect.

B. Connect Ethernet port of hotspot to network device like router or modem via PoE injector or switch.

C. Log in the web GUI via the newly assigned Ethernet port IP address and check the network connection.

Overview	Packet Forward	Cellular	Network	WLAN	VPN	Host List	
WAN							
Port	Status	Type	IP Address	Netmask	Gateway	DNS	Duration
eth 0	up	Static	192.168.22.112	255.255.255.0	192.168.22.1	8.8.8.8	1days.02h 34m 22s

### 5.2 Configure the Wi-Fi Connection

A. Go to “Network” → “Interface” → “WLAN” and select “Client” mode.

B. Click “Scan” to search for a Wi-Fi access point. Select the available one and click “Join Network”.

**Note:** please do use [wired access](#) method to access the web GUI of hotspot, or you will fail to configure Wi-Fi settings.

Port	WLAN	Cellular	Loopback				
<a href="#">&lt; GoBack</a>							
SSID	Channel	Signal	Cipher	BSSID	Security	Frequency	
AAA	Auto	-61dBm	AES	24:e1:24:f0:c4:13	WPA-PSK/WPA2-PSK	2412MHz	<a href="#">Join Network</a>

C. Type the key of Wi-Fi.

Port	WLAN	Cellular	Loopback
<b>WLAN</b>			
Enable	<input checked="" type="checkbox"/>		
Work Mode	Client		<a href="#">Scan</a>
SSID	AAA		
BSSID	24:e1:24:f0:c4:13		
Encryption Mode	WPA-PSK/WPA2-PSK		
Cipher	AES		
Key	.....		
<b>IP Setting</b>			
Protocol	DHCP Client		

D. Go to "Status" → "WLAN" to check Wi-Fi status. If it shows "Connected", it means that the hotspot has connected to Wi-Fi successfully.

Overview	Packet Forward	Cellular	Network	WLAN
<b>WLAN Status</b>				
Wireless Status	Enabled			
MAC Address	24:e1:24:f0:de:14			
Interface Type	Client			
SSID	AAA			
Channel	Auto			
Encryption Type	WPA-PSK/WPA2-PSK			
Cipher	AES			
Status	Connected			
IP Address	192.168.1.145			
Netmask	255.255.255.0			
Connection Duration	0 days, 02:44:45			

E. Go to "Network" → "Failover" → "WAN Failover" to switch the wlan0 as main interface, then gateway can use the Wi-Fi to access the Internet.



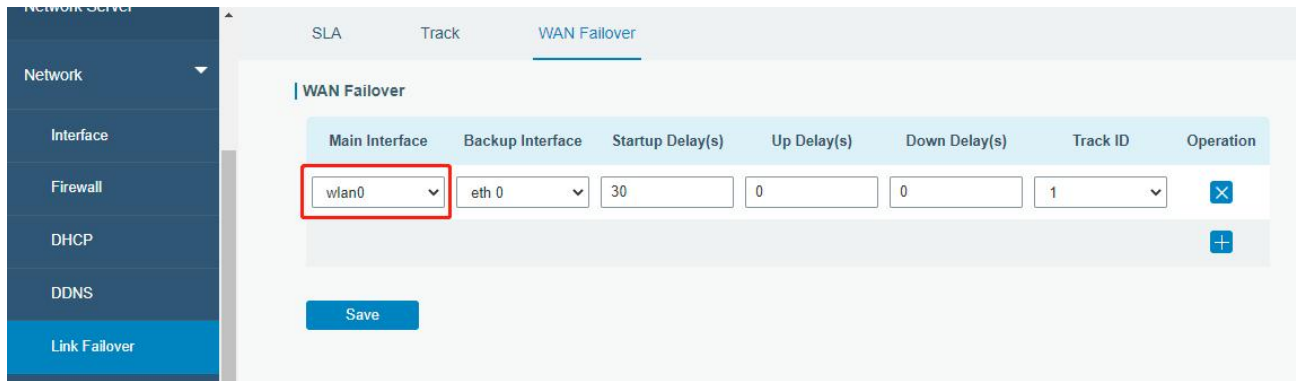

## 5.3 Configure the Cellular Connection

- Go to "Network" → "Interface" → "Cellular" → "Cellular Setting" page to enable cellular settings.
- Choose relevant network type and fill in SIM card information like APN or PIN code, click "Save" and "Apply" for changes to take effect.

Port	WLAN	Cellular	Loopback
<b>Cellular Setting</b>			
Enable		<input checked="" type="checkbox"/>	
Network Type		Auto	
APN			
Username			
Password			
Access Number			
PIN Code			
Authentication Type		Auto	
Roaming		<input checked="" type="checkbox"/>	

- Go to "Status" → "Cellular" page to view the status of the cellular connection. If it shows "Connected", it means the SIM has dialed up successfully. Moreover, you can check the status of the LTE indicator. If it keeps on lighting statically, it means SIM has dialed up successfully.

Overview	Packet Forward	Cellular	Network	WLAN
<b>Modem</b>				
Status	Ready			
Model	EC25			
Version	EC25ECGAR06A07M1G			
Signal Level	23asu (-67dBm)			
Register Status	Registered (Home network)			
IMEI	860425047368939			
IMSI	460019425301842			
ICCID	89860117838009934120			
ISP	CHN-UNICOM			
Network Type	LTE			
PLMN ID				
LAC	5922			
Cell ID	340db83			
<b>Network</b>				
Status	Connected			
IP Address	10.132.132.59			
Netmask	255.255.255.240			
Gateway	10.132.132.60			

## 6. Helium Hotspot Setup

A. Log in the web GUI, click “QR Code for Onboarding” at the top right corner or go to “Helium” → “Onboarding” page.

The screenshot shows the Milesight web GUI interface. At the top right, there is a navigation menu with a link for "QR Code for Onboarding" highlighted with a red box. Below the header, there is a sidebar on the left with various menu items, including "Onboarding" which is currently selected. The main content area displays the "QR Code for Onboarding" page. It features a text input field labeled "Helium Wallet Address" and a "Generate" button, both highlighted with a red box. Below the input field, there is a note: "Note: Ensure that the Internet access is available." Underneath the note is a large empty box with the text "Generate Your QR Code". On the right side of the page, there is a "Help" section with a sub-section for "QR Code for Onboarding" and "Hotspot Events".

B. Fill in the wallet address in hotspot web GUI and click “Generate” to generate the QR code.



C. Download the “**M-Hotspot**” App from Google Play or Apple App Store and open the App to link your Helium wallet. When linking to the Helium wallet page, it’s suggested to use Chrome browser to open the page.



## Welcome to Helium

Play Hotspot, earn Helium, a new cryptocurrency, and participate in building People's Network.

Sign In

Click to link Helium Wallet.

D. Open “M-Hotspot” App, click “+Add Hotspot” and choose the hotspot from the list.



## Add a Milesight Hotspot

Add Hotspot

Transfer Hotspot

After adding a Hotspot, you can view your account on the [Helium Explorer](#).



E. Scan the QR code on the hotspot login web GUI, then App will get the hotspot information. Click "Next".

< Back



## Scan QR Code

You can find the QR code either directly on your product or on the box you received, and you can also visit the local management-console to get the QR code.

Your wallet address is:

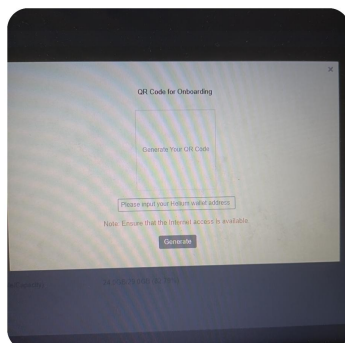

< Back



## Confirm Information

Public Key

MAC Address

24:E1:24:F2:3E:AA

Owner Address

Next

F. Click “Ask for Permissions” to set hotspot location, then click “Set Location”.

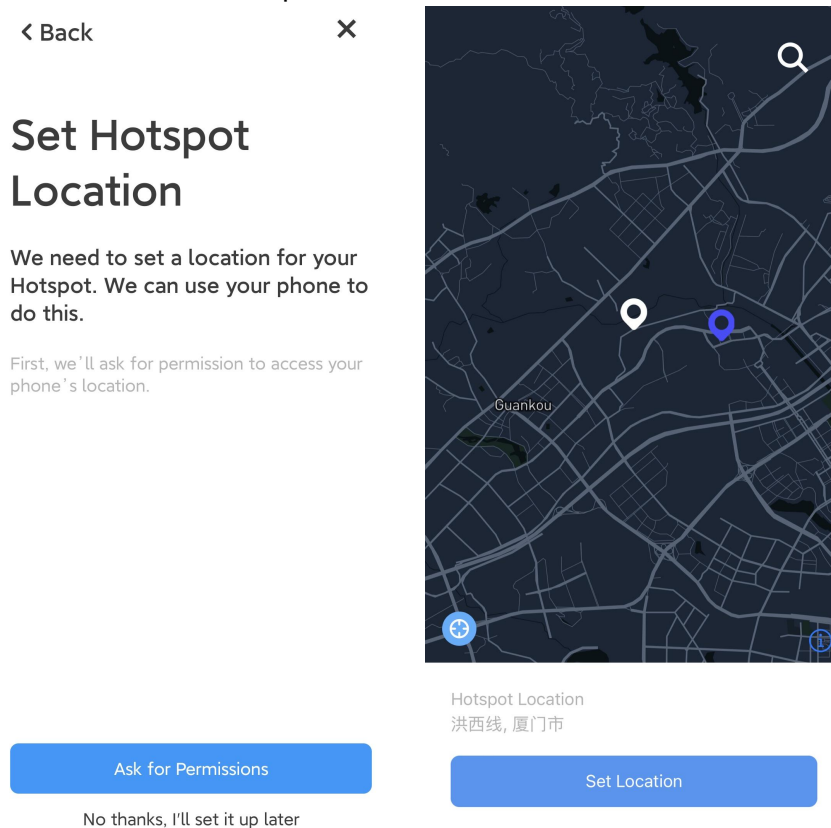

G. Set hotspot antenna gain and height according to your external antenna type, it's 5dBi by default. Click “Next” and “Register Hotspot”. This registration requires \$10 and it's already prepaid by Milesight.

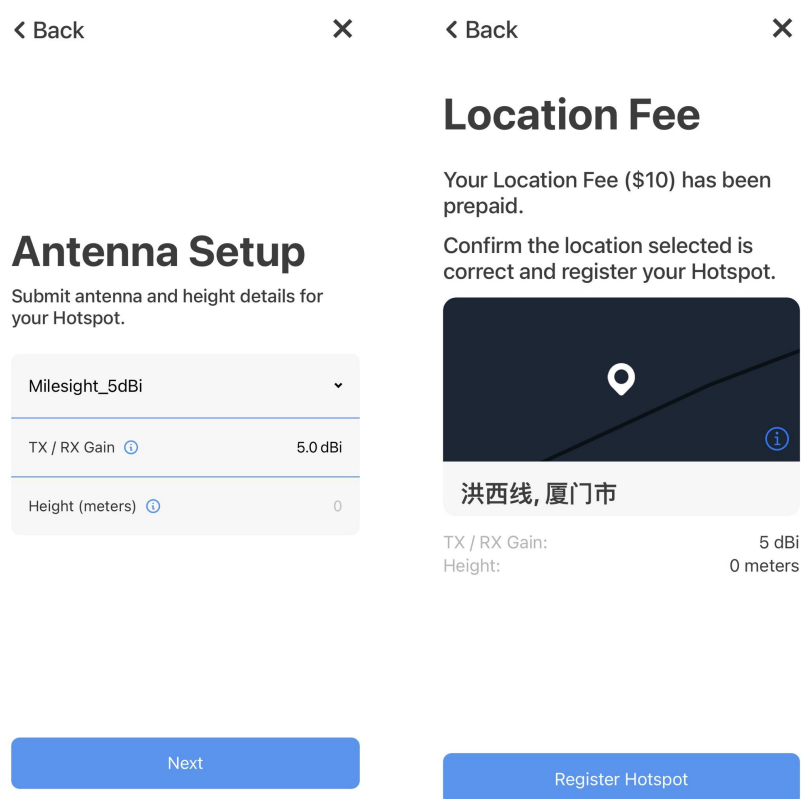

H. When registering, it will skip to Helium App page, click "I Confirm" to update the info and add your hotspot to the Helium network.

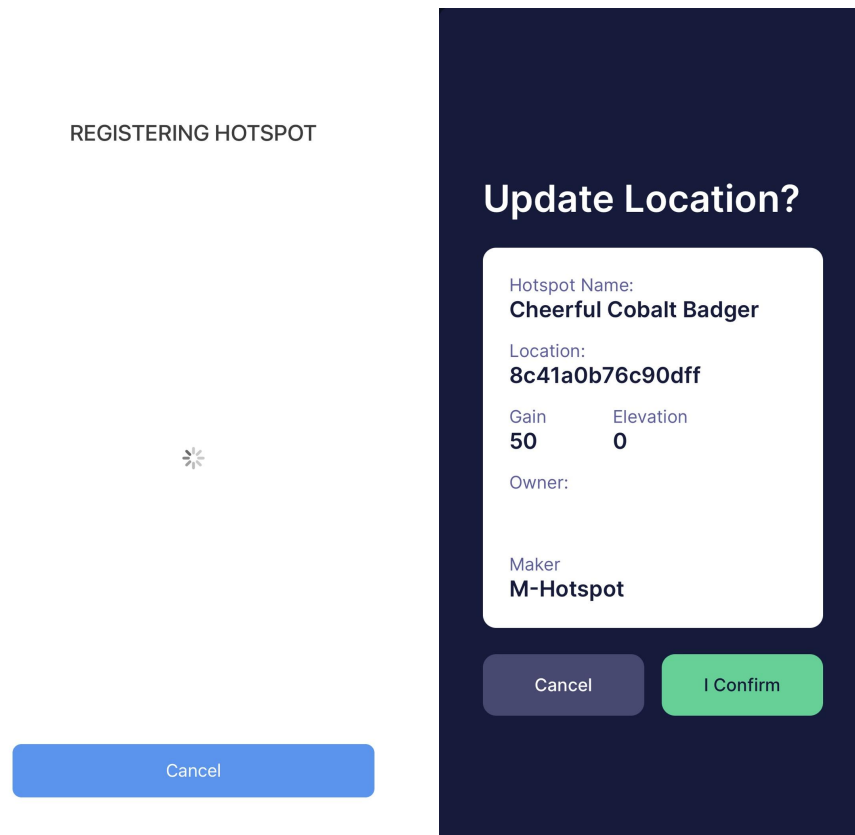

## 7. Helium Advanced Setting

UG67 Helium hotspot provides options to get the Helium process status and control.

### 7.1 Hotspot

This page is used for displaying the basic information of onboarding hotspot.

Status	
Hotspot Name	cheerful-cobalt-badger
Network Status	Online
Validator	1.12.4 (1454297)
Owner	13bKkGS6iASivVtrUWbcQcpzGVTFuGR1yU1BFut5kRn5fwWYb4R
Public IP Address	103.84.136.171

Item	Description
Hotspot Name	A unique identifier for the onboarded hotspot in the Helium network.
Network Status	Show the status of hotspot connections to the Internet.
Validator	Show the version and block height of the validator which the device is connected.
Owner	Show the wallet address this hotspot binds to, and the refresh frequency is once a day.
Public IP Address	Show the network export IP address of the hotspot.

## 7.2 Onboarding

This page is used for generating QR code for onboarding and checking hotspot events. You can also click the button on the top right corner to generate the QR code.

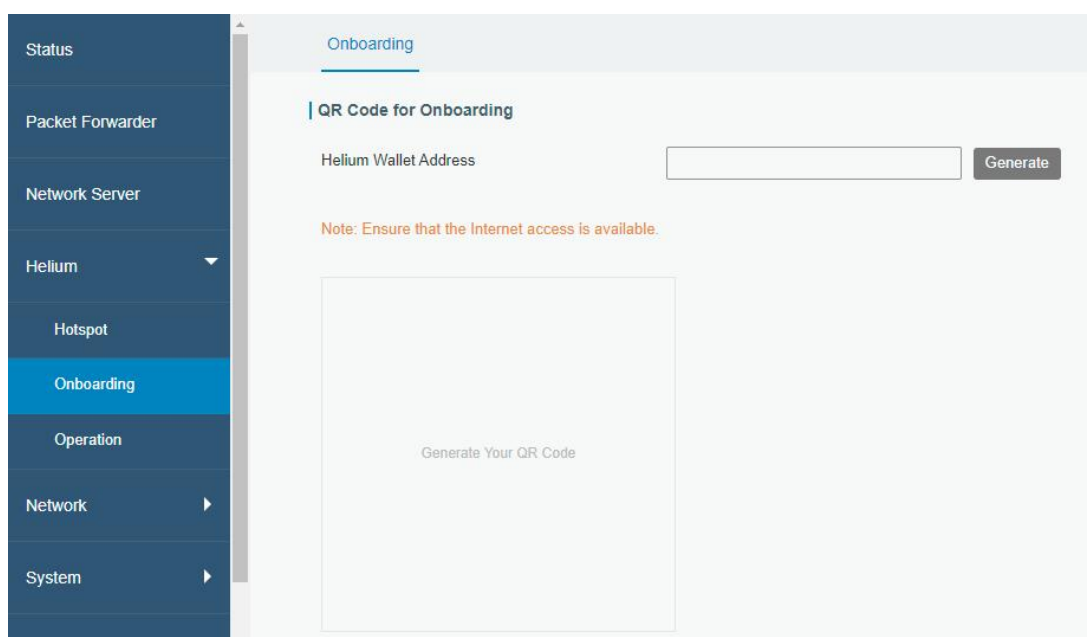

Item	Description
QR Code for Onboarding	Type the wallet address, then click “Generate” to generate the QR code for hotspot onboarding. Before generating, ensure the hotspot can access the Internet.
Hotspot Events	Click “View” to check hotspot transaction status and information. Including onboard and transfer hotspot.

## 7.3 Operation

This page is used for setting Helium upgrade interval and operating the Helium process.

Operation	
Item	Description
<b>Automatic Upgrade</b>	
Helium Version	Show the current hotspot Helium program version.
Helium Profiles	Show the current used Helium profile version.
Enable	When enabled, the hotspot will check and upgrade the Helium program version automatically.
Upgrade Schedule	Set the time interval of checking Helium version. If there is a newer version, the hotspot will update the version automatically. Range: 1-168 hours.
<b>Helium Log</b>	
Download	Download the Helium logs containing the Helium progress running status, configuration changes, and so on.
<b>Helium Reboot</b>	
Reboot	Reboot the Helium progress.
<b>Helium Reset</b>	
Reset	Reset the Helium progress and block data, then download the latest Helium progress automatically.





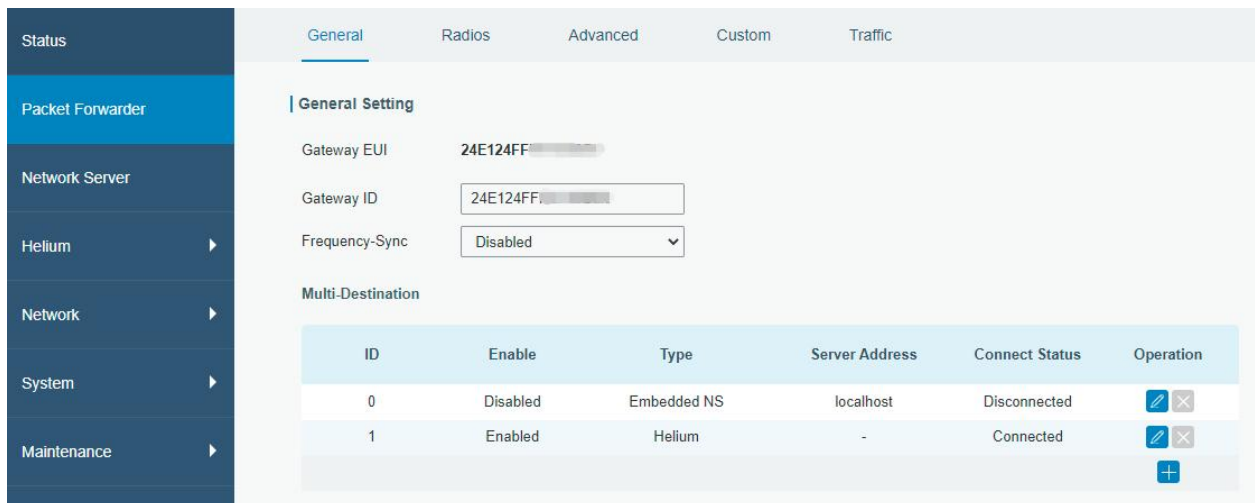

## 8. Packet Forwarder Configuration

UG67 has installed multiple packet forwarders including Semtech, Chirpstack-Generic MQTT broker, etc.

A. Go to “Packet Forwarder” → “General” page and click  to add a network server.



ID	Enable	Type	Server Address	Connect Status	Operation
0	Disabled	Embedded NS	localhost	Disconnected	 
1	Enabled	Helium	-	Connected	 

B. Fill in the server information and enable this server. If Helium is enabled, you can enable Semtech, Chirpstack type package forwarder or remote Embedded NS at the same time.

**Note:** when you add any NS or modify the NS setting and click “Save & Apply”, the Helium program will reboot and disconnect for dozens of seconds.

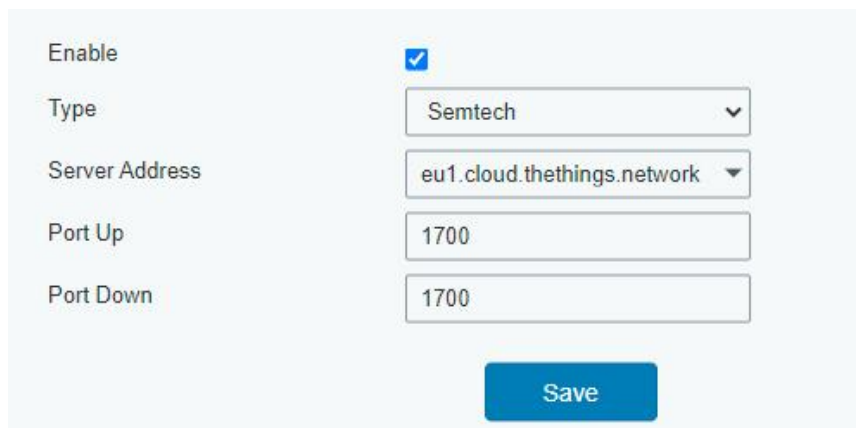

Enable

Type

Server Address

Port Up

Port Down

C. Go to “Packet Forwarder” → “Radio” page to configure antenna type, center frequency and channels. The channels of the gateway and network server need to be the same.

Region US915

Name	Center Frequency/MHz
Radio 0	904.3
Radio 1	905.0

**Multi Channels Setting**

Enable	Index	Radio	Frequency/MHz
<input checked="" type="checkbox"/>	0	Radio 0	903.9
<input checked="" type="checkbox"/>	1	Radio 0	904.1
<input checked="" type="checkbox"/>	2	Radio 0	904.3
<input checked="" type="checkbox"/>	3	Radio 0	904.5
<input checked="" type="checkbox"/>	4	Radio 1	904.7
<input checked="" type="checkbox"/>	5	Radio 1	904.9
<input checked="" type="checkbox"/>	6	Radio 1	905.1
<input checked="" type="checkbox"/>	7	Radio 1	905.3

D. Add the hotspot to the network server page. For more details about the network server configuration please refer to network server guide or [Milesight IoT Support portal](#).

E. After connected, you can check connection status here.

Status

Packet Forwarder

Network Server

Helium

Network

System

Maintenance

APP

General   Radios   Advanced   Custom   Traffic

**General Setting**

Gateway EUI 24E124FF1

Gateway ID 24E124FF1

Frequency-Sync Disabled

Multi-Destination

ID	Enable	Type	Server Address	Connect Status	Operation
0	Enabled	Embedded NS	localhost	Connected	✎ ✕
1	Enabled	Helium	-	Disconnected	✎ ✕
2	Enabled	Semtech	eu1.cloud.thethings.network	Connected	✎ ✕

## 9. Network Server Configuration

UG67 can work as network server and transmit data to Milesight IoT Cloud or other platform via MQTT/HTTP/HTTPS.

### 9.1 Connect UG67 to Milesight IoT Cloud

A. Go to "Packet Forwarder" → "General" page to enable the embedded network server.

**Note:** when you enable and click "Save & Apply", the Helium program will reboot and disconnect for dozens of seconds.

General Radios Advanced Custom Traffic

**General Setting**

Gateway EUI 24E124FF

Gateway ID 24E124FF

Frequency-Sync Disabled

Multi-Destination

ID	Enable	Type	Server Address	Connect Status	Operation
0	Enabled	Embedded NS	localhost	Connected	<a href="#">✎</a> <a href="#">✕</a>
1	Enabled	Helium	-	Connected	<a href="#">✎</a> <a href="#">✕</a>

B. Go to “Packet Forwarder” → “Radio” page to select the antenna type, center frequency and channels. The channels of the gateway and nodes need to be the same.

Region US915

Name	Center Frequency/MHz
Radio 0	904.3
Radio 1	905.0

Multi Channels Setting

Enable	Index	Radio	Frequency/MHz
<input checked="" type="checkbox"/>	0	Radio 0	903.9
<input checked="" type="checkbox"/>	1	Radio 0	904.1
<input checked="" type="checkbox"/>	2	Radio 0	904.3
<input checked="" type="checkbox"/>	3	Radio 0	904.5
<input checked="" type="checkbox"/>	4	Radio 1	904.7
<input checked="" type="checkbox"/>	5	Radio 1	904.9
<input checked="" type="checkbox"/>	6	Radio 1	905.1
<input checked="" type="checkbox"/>	7	Radio 1	905.3

C. Go to “Network Server” → “General” page to enable the network server and “Milesight IoT Cloud” mode.

General Applications Profiles Device Multicast Groups

**General Setting**

Enable

Cloud Mode  Milesight IoT Cloud

NetID 010203

Join Delay 5 sec

D. Log in the Milesight IoT Cloud. Then go to “My Devices” page and click “+New Devices” to add

hotspot to Milesight IoT Cloud via SN. Gateway will be added under “Gateways” menu.

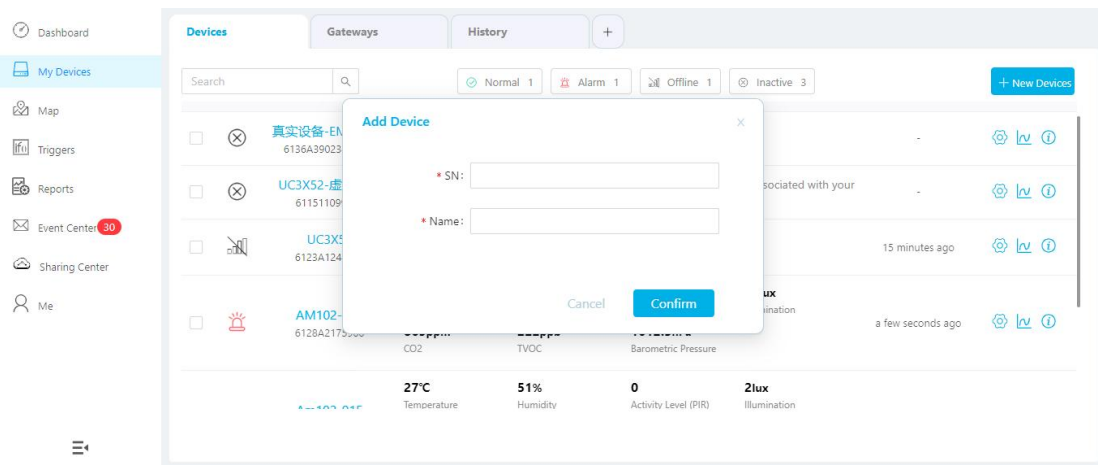

E. The hotspot is online on Milesight IoT Cloud.

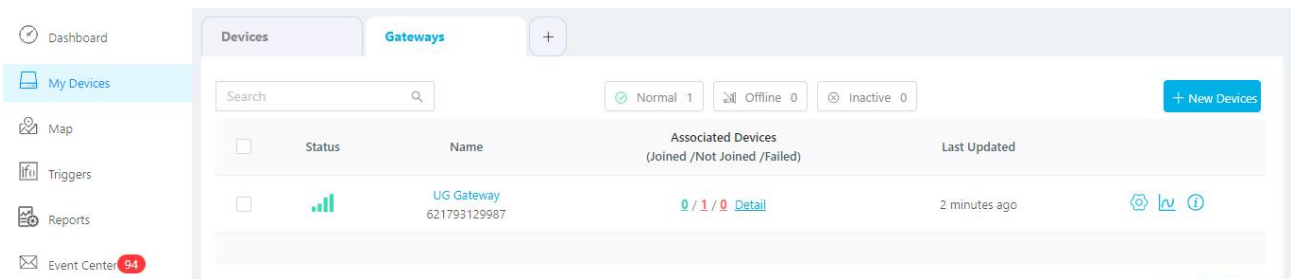

## 9.2 Connect UG67 to MQTT/HTTP Server

A. Go to “Packet Forwarder” → “General” page to enable the embedded network server.

**Note:** when you add any NS or modify the NS setting and click “Save & Apply”, the Helium program will reboot and disconnect for dozens of seconds.

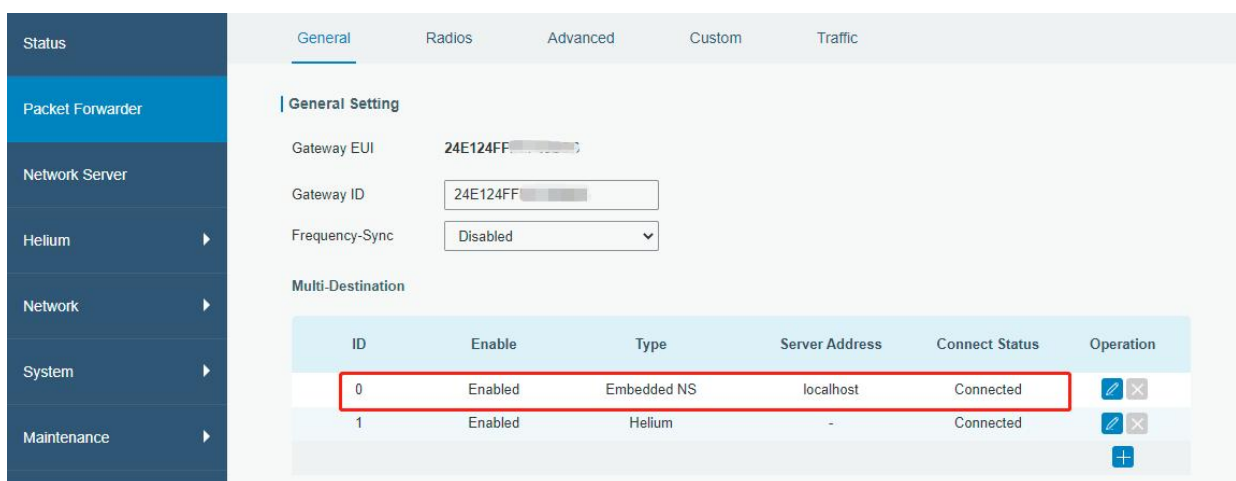

B. Go to “Packet Forwarder” → “Radio” page to select the antenna type, center frequency and channels. The channels of the gateway and nodes need to be the same.

Region US915

Name	Center Frequency/MHz
Radio 0	904.3
Radio 1	905.0

Multi Channels Setting

Enable	Index	Radio	Frequency/MHz
<input checked="" type="checkbox"/>	0	Radio 0	903.9
<input checked="" type="checkbox"/>	1	Radio 0	904.1
<input checked="" type="checkbox"/>	2	Radio 0	904.3
<input checked="" type="checkbox"/>	3	Radio 0	904.5
<input checked="" type="checkbox"/>	4	Radio 1	904.7
<input checked="" type="checkbox"/>	5	Radio 1	904.9
<input checked="" type="checkbox"/>	6	Radio 1	905.1
<input checked="" type="checkbox"/>	7	Radio 1	905.3

C. Go to “Network Server” → “General” page to enable the network server mode.

Status	General	Applications	Profiles	Device
Packet Forwarder	General Setting			
Network Server	Enable <input checked="" type="checkbox"/>	Cloud Mode <input type="checkbox"/>		
Helium	NetID	010203		
Network	Join Delay	5 sec		
System	RX1 Delay	1 sec		
	Lease Time	8760-0-0 hh-mm-ss		
	Log Level	info		

D. Go to “Network Server”→“Application” to add a new application.

General	Applications	Profiles	Device
Applications			
Name	cloud		
Description	cloud		
Payload Codec	None		

After saving the application, you can select HTTP, HTTPS or MQTT protocol and fill in correspond server information to send data to another server.

**Data Transmission**

Type

Status

**General**

Broker Address

Broker Port

Client ID

Connection Timeout/s

Keep Alive Interval/s

E. Go to “Profiles” page to add a new profile for the device.

General Applications **Profiles** Device

**Device Profiles**

Name

Max TXPower

Join Type

Class Type  Class A  Class B  Class C

Advanced

F. Go to “Device” page and click “Add” to add LoRaWAN® node devices.

General Applications Profiles **Device** Gateways Packets

**Device**

Search

Device Name	Device EUI	Device-Profile	Application	Last Seen	Activated	Operation
No matching records found						

You can also click “Bulk Import” if you want to add all nodes at once.

Click “Template Download” to download template file and add device information to this file. Application and device profile should be the same as you created on web page.

	A	B	C	D	E	F	G	H	I
1	name	description	deveui	application	deviceprofile	appkey	devaddr	appskey	nwkskey
2	24e1242191323266		24e1242191323266	cloud	ClassC-OTAA	112233445566778899aa112233445566			
3									
4									
5									

Import this file to add bulks of devices.

G. Go to “Packets” page to check the packets from LoRaWAN® node devices. The type starts from “Up” means uplinks and “Dn” means downlinks.

Device EUI	Frequency	Datarate	SNR	RSSI	Size	Fcnt	Type	Time	Details
24e124126a146579	868300000	SF7BW125	8.5	-85	4	14	UpUnc	2020-04-28T15:09:25+08:00	!
24e124126a146579	868300000	SF7BW125	10.2	-75	4	13	UpUnc	2020-04-28T15:04:25+08:00	!

Click “Details” to check the properties and payload contents of packets.

Packets Details	
Fcnt	14
Port	85
Modulation	LORA
Bandwidth	125
SpreadFactor	7
Bitrate	0
CodeRate	4/5
SNR	8.5
RSSI	-85
Power	-
Payload(b64)	A3cYAA==
Payload(hex)	03771800
MIC	f5acdeb2

**[END]**